



FISCHER MINIMAX™ SERIES

CABLE ASSEMBLY INSTRUCTIONS

WITH OPTIONAL BOOT BEND RELIEF



THE RELIABLE EXPERT

fischer[®]
CONNECTORS



REQUIRED TOOLING

To successfully cable the Fischer MiniMax Series tooling is required to insure proper alignment of the various parts that need to be assembled. The below instructions are valid for cable assemblies on both plug (MP11) and cable receptacle (MR50) for both sizes 06 and 08, independent of locking or coding.

Generic Tools

Hand press Vogt 4255 (FC Reference 130257) or equivalent

Specific Tools

MiniMax support tool (FC Reference 130254)



MiniMax tool kit

Size 06 (FC Reference 130252)
Size 08 (FC Reference 130253)

Tool 1. : used for assembly of MP11

Tool 2. : used for assembly of MR50

Tool 3. : double sided tool for insertion of contact block (housing) and back nut for both MP11 and MR50





PARTS DESCRIPTION

Connector parts

In the tube

1. Contact block
2. Insulator tube
3. Guide mark ring (used for overmolding only)
4. Contact block O-ring
5. Housing O-ring

Separate parts

6. Housing
7. Back nut

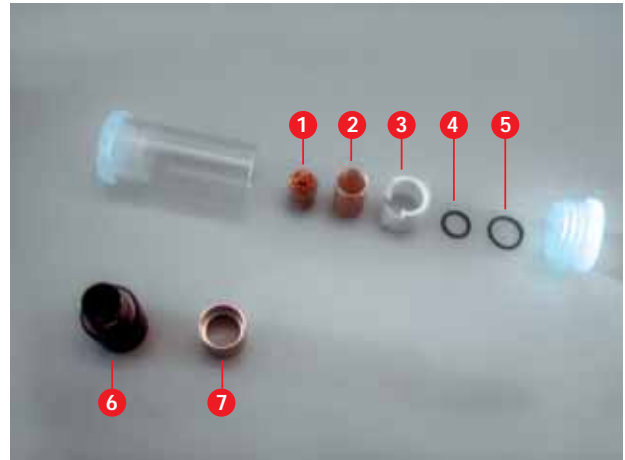

Bend relief

1. Clip
2. Boot bend relief



CUTTING DIAMETERS

Size	Uncut	Level 1	Level 2
06	ø2.9	ø3.9	ø5.7
08	ø3.9	ø5.4	ø6.7

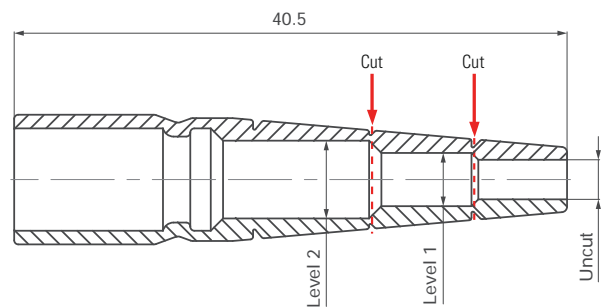



PROCEDURE

1

Cut the bend relief to adjust it to the cable diameter.
Slide the bend relief + clip + back nut + insulator tube on the cable as shown in the picture.



2

Strip the cable jacket to 14mm.
(for both size 06 and 08).



3

Pull back the braid over the jacket.
We recommended to use a clear tape to hold the braid on the jacket.



4

Trim back and strip the conductors according to following specifications:

Position	Trim back	Strip
External	-	1.5mm
Intermediate	1.5mm	1.5mm
Central	3mm	1.5mm

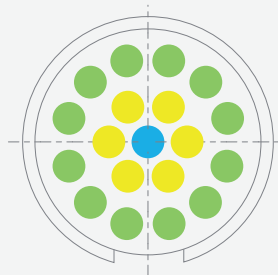

Illustration shows 19 contacts.
Same principle of up to 3 levels (external, intermediate, central) applies for all MiniMax configurations.
If only 1 level, use External level.
If 2 levels, use External and Intermediate levels.

5

Solder all conductors to the contact block.



See technical specifications for wire numbering.
In order to use the correct numbering scheme, please note that the landmark used to fix the contact block on the insulator tube (see arrow in the picture on the right) is OPPOSITE to the grounding pin represented on the PCB hole layout diagram in the MiniMax technical specifications.





PROCEDURE

6

Slide the insulator tube onto the contact block using the «poka yoke» mismatch protection for correct orientation.



7

Pull back the braid from the insulator tube on the cable jacket.



8

The insulator tube can be glued on the contact block for better retention.

(Loctite 406 glue recommended)





PROCEDURE

9

Potting of the insulator tube through the hole (upper limit = blue line). Insulator tube can be pre-heated if necessary.

We recommend to use a heat shrinkable sleeve to cover the filling-hole to avoid potting material coming out of the hole once potted.

Curing time and conditions according to your potting material.

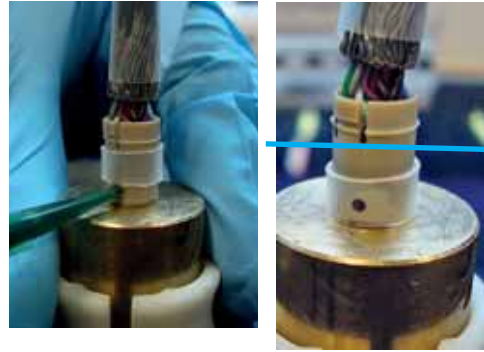

10

Put the O-rings on the contact block (with grease) and on the housing.



11

Initial setup

Make sure the support tool (130254) is properly centered on the table press (130257) using the alignment tool provided.

Insertion of the insulator tube with the press.

Insert the insulator tube into the housing with the multifunction press until it clips on.

Use the appropriate tool set for Minimax 08 (130253) or Minimax 06 (130252).

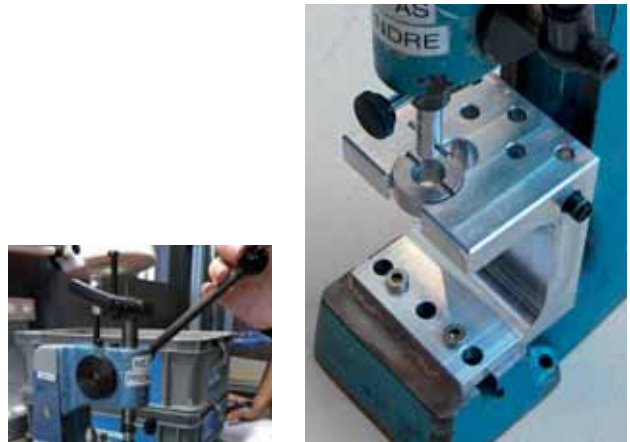

" tool 1 " for MP11
" tool 2 " for MR50

" tool 3 " "Housing" facing up

Make sure to align the nose of the insulator with the housing before the insertion operation.





CABLE ASSEMBLY TYPES

12

Pull up the braided shield.



13

Cut off the braided shield to a length slightly inferior to the O-ring location.

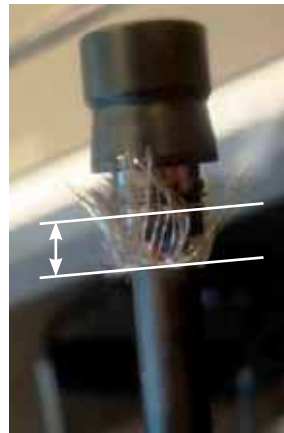

14

Fitting of the backnut with the press.

Press-fit the backnut with the multifunction press using the appropriate tool set for Minimax 08 (130253) or Minimax 06 (130252).

" tool 1 " for MP11

" tool 2 " for MR50

" tool 3 " " Back nut " facing up

The backnut is now in position.

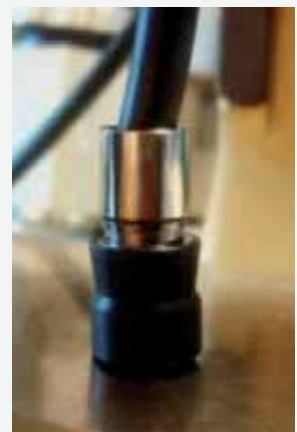



PROCEDURES

15

Potting of the back nut through the hole.

First fix the boot bend relief clip on the back nut.

Make sure the potting material entirely fills the space between the clip and the nut, all the way to the top of the clip.

We recommend using a heat shrinkable sleeve to cover the filling-hole to avoid potting material coming out of the hole once potted.

Curing time and conditions according to your potting material



16

Slide the boot bend relief over the back nut until it firmly hooks on the clip.

Congratulations with your terminated MiniMax.





+ Headquarters
 ▼ Subsidiaries
 ● Offices
 ● Distributors

Headquarters

FISCHER CONNECTORS SA
 Ch. du Glapin 20
 1162 Saint-Prex - Switzerland
 Phone +41 21 800 95 95
Free phone +41 800 800 008
 mail@fischerconnectors.chw

Germany, Austria & Eastern Europe
FISCHER CONNECTORS GmbH
 Zorneding
 Phone +49 8106 37722 0
Gebührenfrei: 0 800 233 3233
 www.fischerconnectors.de
 mail@fischerconnectors.de

United Kingdom & Ireland
FISCHER CONNECTORS Ltd.
 Waterlooville, Hampshire
 Phone +44 23 9245 9600
Toll free: 0 800 432 0301
 www.fischerconnectors.co.uk
 sales@fischerconnectors.co.uk

United States & Canada
FISCHER CONNECTORS, Inc.
 Atlanta, GA
 Phone +1 678 393 5400
Toll free : 800 551 0121
 www.fischerconnectors.com/us
 mail@fischerconnectors.com

Italy
FISCHER CONNECTORS Srl
 Monza
 Phone +39 039 734 072
 www.fischerconnectors.it
 mail@fischerconnectors.it

India
FISCHER CONNECTORS
India Pvt. Ltd.
 Gurgaon - Haryana
 Phone +91 124 4255642 to 45
 www.fischerconnectors.com
 salesin@fischerconnectors.in

France
FISCHER CONNECTORS Sarl
 Paris
 Phone +33 1 5578 2578
Appel gratuit : 0 800 590 444
 www.fischerconnectors.fr
 mail@fischerconnectors.fr

Sweden
FISCHER CONNECTORS AB
 Nacka
 Phone +46 72 387 02 04
 www.fischerconnectors.com
 mail@fischerconnectors.se

Asia
FISCHER CONNECTORS ASIA Ltd.
 Hong Kong
 Phone +852 2620 6118
 www.fischerconnectors.hk
 mail@fischerconnectors.hk

